

# CARVER PRO

## Xi1850 / Xi2600 User Manual





# CAUTION

**RISK OF ELECTRIC SHOCK  
DO NOT OPEN**



CAUTION: TO REDUCE THE RISK OF ELECTRIC SHOCK, DO NOT REMOVE THE COVER. NO USER SERVICEABLE PARTS INSIDE. REFER SERVICING TO QUALIFIED PERSONNEL!

**Please read this entire manual, especially the Instructions and Warnings, before operating**

## Explanation of Symbols



The lightning flash with the arrowhead symbol within an equilateral triangle is intended to alert the user to the presence of uninsulated “dangerous voltage” within the products’ enclosure that may be of sufficient magnitude to constitute a risk of electric shock to persons.



The exclamation point within an equilateral triangle is intended to alert the user of the presence of important operating and maintenance (servicing) instructions in the literature accompanying the appliance.

## IMPORTANT SAFETY INSTRUCTIONS

- 1) Read these instructions.
- 2) Keep these instructions.
- 3) Heed all warnings.
- 4) Follow all instructions.
- 5) Do not use this apparatus in or near water.
- 6) Clean only with a dry cloth.
- 7) Do not block any ventilation openings. Install in accordance with the manufacturer’s instructions.
- 8) Do not install near any heat sources such as radiators, heat registers, stoves, or other apparatus that produce heat.
- 9) Do not defeat the safety purpose of the polarized or grounding-type plug. A polarized plug has two blades with one wider than the other. A grounding-type plug has two blades and a third grounding prong. The wide blade or the third prong is provided for your safety. If the provided plug does not fit into your outlet, consult an electrician for replacement of the obsolete outlet.
- 10) Protect the power cord from being walked on or pinched, particularly at plugs, convenience receptacles, and the point where they exit from the apparatus.
- 11) Only use attachments/accessories specified by the manufacturer.
- 12) Unplug this apparatus during lightning storms or when unused for long periods of time.
- 13) Refer all servicing to qualified service personnel. Servicing is required when the apparatus has been damaged in any way, such as power supply cord or plug is damaged, liquid has been spilled or objects have fallen into the apparatus, the apparatus has been exposed to rain or moisture, does not operate normally, or has been dropped.



**TO REDUCE THE RISK OF FIRE OR ELECTRIC SHOCK, DO NOT EXPOSE THIS APPARATUS TO RAIN OR MOISTURE.**



**TO PREVENT ELECTRIC SHOCK DO NOT REMOVE TOP OR BOTTOM COVERS. NO USER SERVICEABLE PARTS INSIDE. REFER SERVICING TO QUALIFIED SERVICE PERSONNEL.**

### FCC COMPLIANCE NOTICE

This device complies with part 15 of the FCC rules. Operation is subject to the following two conditions: (1) This device may not cause harmful interference, and (2) this device must accept any interference received, including interference that may cause undesired operation.

**CAUTION:** Changes or modifications not expressly approved by the party responsible for compliance could void the user’s authority to operate the equipment.

**NOTE:** This equipment has been tested and found to comply with the limits for a Class B digital device, pursuant to part 15 of the FCC Rules. These limits are designed to provide reasonable protection against harmful interference in a residential installation. This equipment generates, uses, and can radiate radio frequency energy and, if not installed and used in accordance with the instruction manual, may cause harmful interference to radio communications. However, there is no guarantee that interference will not occur in a particular installation. If this equipment does cause harmful interference to radio or television reception, which can be determined by turning the equipment off and on, the user is encouraged to try to correct the interference by one or more of the following measures:

- Reorient or relocate the receiving antenna.
- Increase the separation between the equipment and receiver.
- Connect the equipment into an outlet on a circuit different from that to which the receiver is connected.

### IMPORTANT

Xi1850 and Xi2600 amplifiers require Class 2 output wiring.

### MAGNETIC FIELD

**CAUTION!** Do not locate sensitive high-gain equipment such as preamplifiers or tape decks directly above or below the unit. Because this amplifier has a high power density, it has a strong magnetic field, which can induce hum into unshielded devices that are located nearby. The field is strongest just above and below the unit. If an equipment rack is used, we recommend locating the amplifier(s) in the bottom of the rack and the preamplifier or other sensitive equipment at the top.

# TABLE OF CONTENTS

<b>Safety Instructions</b>	<b>2</b>
Important Safety instructions	2
FCC Compliance Notice	2
Magnetic Field Warning	2
<b>Table of Contents</b>	<b>3</b>
<b>Introduction</b>	<b>3</b>
Unpacking	3
Important Paperwork	3
<b>Power Specifications</b>	<b>4</b>
<b>Features</b>	<b>4</b>
<b>Front Panel Controls &amp; Features</b>	<b>5</b>
<b>Rear Panel Controls &amp; Features</b>	<b>6</b>
<b>Installation</b>	<b>7</b>
Location and General Precautions	7
Mechanical Considerations	7
Rear Support for Road Applications	7
Thermal Considerations	7
AC Power Considerations	7
Magnetic Leakage Considerations	7
Input Wiring	7
Output Wiring	7
Multi-Way Binding Posts	8
Speakon	8
Polarity	8
Bridged Mono Operation	8
Dual Mono Operation	8
DIP Switches	8
Signal Smart	8
70 Volt Direct Drive	9
<b>Performance Specifications</b>	<b>9</b>
<b>Warranty Information</b>	<b>10</b>
<b>Care and Service Assistance</b>	<b>10</b>
<b>In Case of Difficulty</b>	<b>11</b>

# INTRODUCTION

Congratulations on choosing the Carver Professional Xi Series Amplifier! The Xi Series amplifiers have superior fidelity and the capability to drive low impedances. Our Xi series can deliver generous power levels, even at 2 Ohm stereo loads. By design, the Xi Series power amplifiers are very accurate and efficient. Your Xi Series amplifier will give you many years of outstanding service and reliability.

## Unpacking

Inside the box you will find; one Xi Series Amplifier, four self-adhesive rubber feet, and an owner's manual and warranty card.

Carefully unpack the amplifier and keep the original carton and packing materials for future moving, shipment or long-term storage. After opening the box, please check for visible signs of damage that were not apparent from the outside of the box. If you encounter what appears to be concealed damage, please consult your Carver Professional Dealer before installing unit.

## Important Paperwork

Make sure to save your sales receipt. Your receipt is extremely important to establish the duration of your Limited Warranty and for insurance purposes. Next, make a note of the serial number, which is located on the back of the amplifier. Record it in the space provided below for convenient reference.

**Serial Number:** \_\_\_\_\_ **Purchased at:** \_\_\_\_\_

**Date:** \_\_\_\_\_

Finally, take a moment to fill out the Warranty Registration Card packed with the amplifier and return it to Carver Professional. This will allow us to keep you informed about new products as they become available.

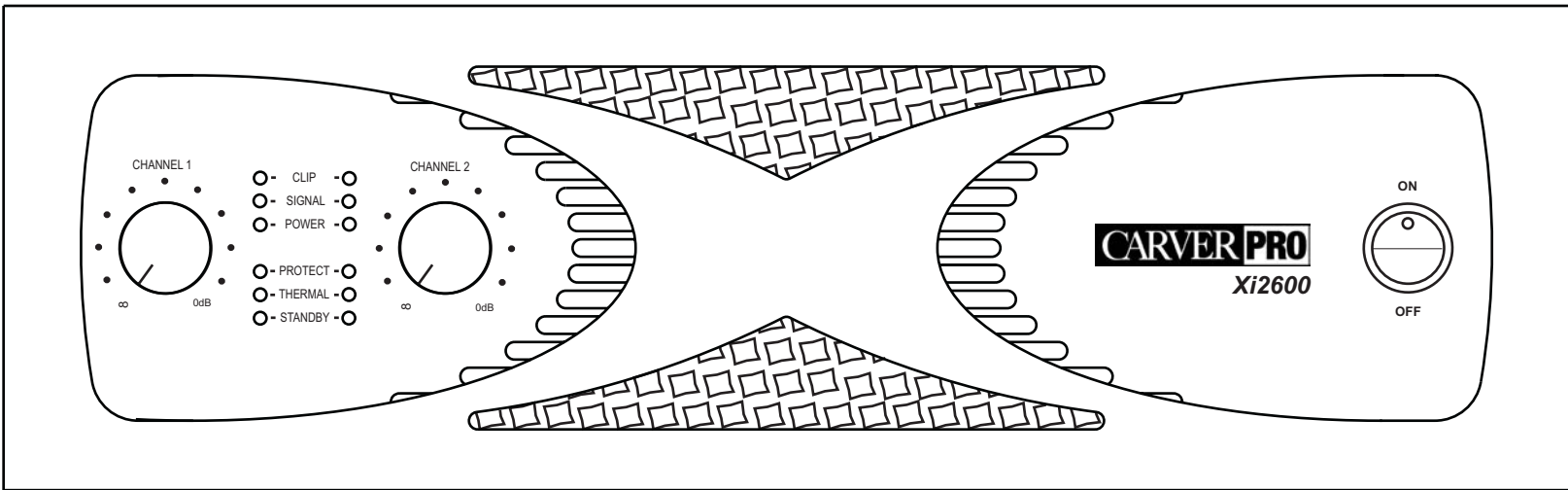

## POWER SPECIFICATIONS

### Xi1850

- 370W per channel into 8 ohm stereo loads, 20 Hz to 20 kHz, with less than 0.5% THD+N
- 585W per channel into 4 ohm stereo loads, 20 Hz to 20 kHz, with less than 0.5% THD+N
- 925W per channel into 2 ohm loads, 1 kHz, with less than 1% THD+N
- 1170W bridged mono into 8 ohms, 20 Hz to 20 kHz with less than 1% THD+N
- 1850W bridged mono into 4 ohms, 1 kHz with less than 1% THD+N

### Xi2600

- 500W per channel into 8 ohm stereo loads, 20 Hz to 20 kHz, with less than 0.5% THD+N
- 800W per channel into 4 ohm stereo loads, 20 Hz to 20 kHz, with less than 0.5% THD+N
- 1300W per channel into 2 ohm loads, 1 kHz, with less than 1% THD+N
- 1600W bridged mono into 8 ohms, 20 Hz to 20 kHz with less than 1% THD+N
- 2600W bridged mono into 4 ohms, 1 kHz with less than 1% THD+N

## FEATURES

- Stable 2 Ohm operation
- Variable speed ultra-quiet fan cooling
- 7 LED level display, per channel, including signal present and clip indicators
- Power ready, Signal Present, Clip, Protect, Thermal and Standby LED indicators for each channel
- Level control defeat can be accessed from rear panel
- Switched 40 Hz / 80 Hz (12 dB/octave cut) High Pass and Low Pass Filters
- Switched Soft Knee Clip Limiters

- Soft Start In-Rush Current Limiting
- Input via 1/4" TRS and XLR connectors
- Speaker Outputs via Neutrik® Speakon® connectors
- Speaker Outputs via two pairs of Multi-Way binding posts
- Power Switch, 2 positions: ON, OFF
- Heavy Duty AC Line Cord
- Optional Accessories: 70 Volt Line Transformer

# Front Panel Controls and Features

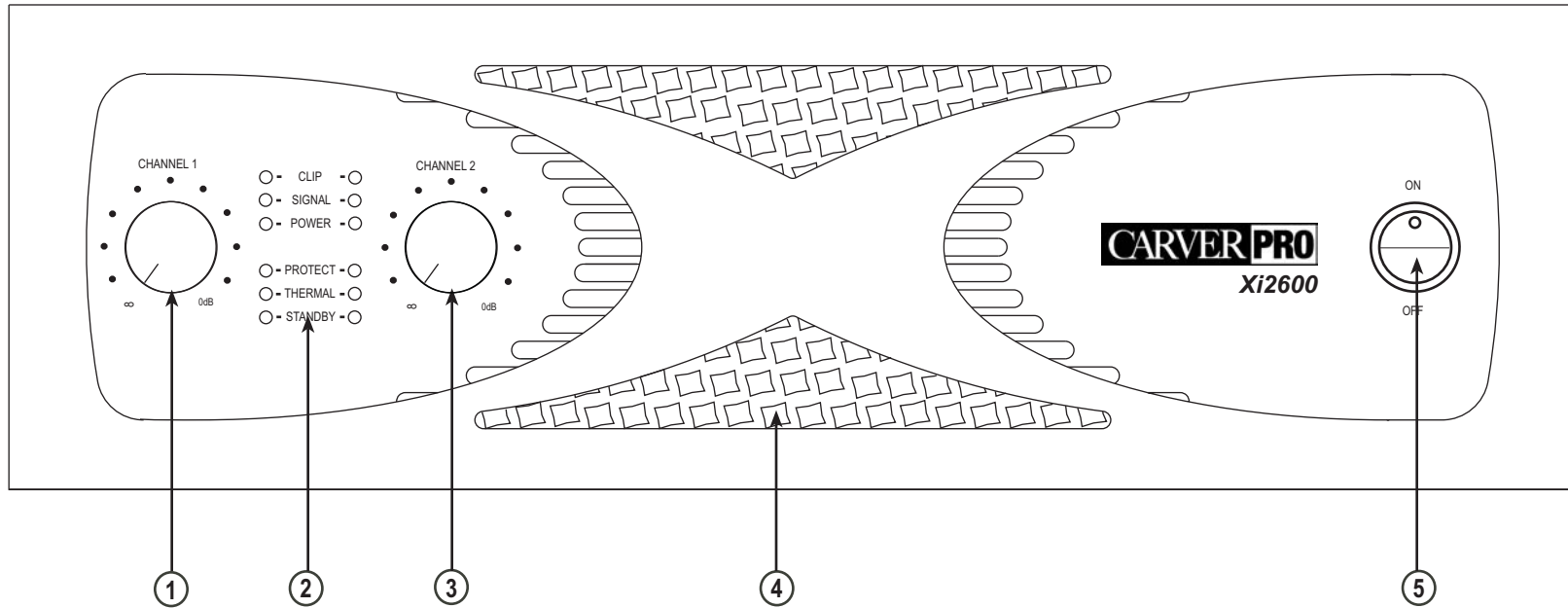

**1** Channel 1 Level Control is a 41 detent potentiometer allowing adjustment from infinite attenuation to 0dB attenuation in 40 steps. Level controls may be bypassed from rear panel.

**2** Status LEDs - From top to bottom: One Red "Clip" indicator per channel, one Yellow "Signal Present" indicator per channel, one Green "Power ON" indicator per channel, one Red "Protection" indicator per channel, one Red "Thermal Overload" indicator per channel and one Yellow "Standby" indicator per channel.

**3** Channel 2 Level Control is a 41 detent potentiometer allowing adjustment from infinite attenuation to 0dB attenuation in 40 steps. Level controls may be bypassed from rear panel.

**4** Ventilation openings for fan cooling. Caution should be taken to keep the ventilation opening free from any obstruction to assure proper cooling. The fans force air from the back to front of the Xi amplifiers.

**5** Power Switch - Press up for the "ON" position or press down for the "OFF" position.

# Rear Panel Controls and Features

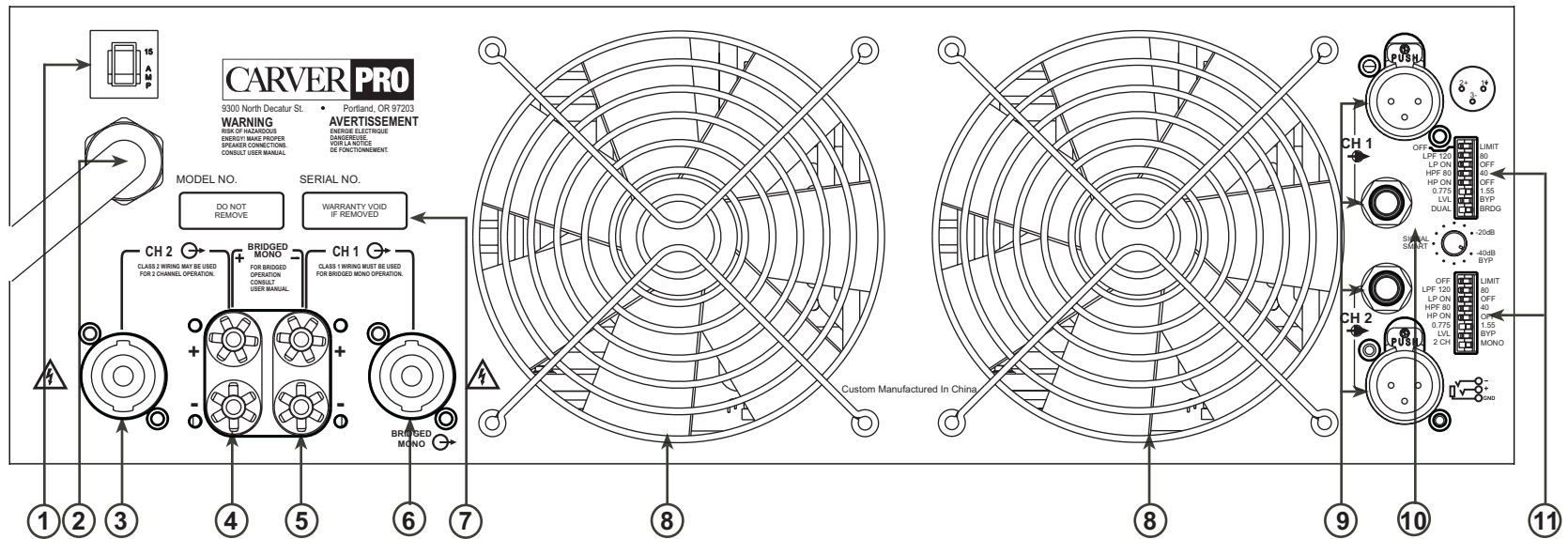

- 1 AC Mains Circuit Breaker will protect the amplifier against excessive current draw. Should the breaker trip, wait, turn off the power switch, then press in to reset.
- 2 AC Mains Power Cord. Caution should be used to protect the power cord from damage to prevent the possibility of electric shock.
- 3 Channel 2 Speakon<sup>®</sup> connector. Used to connect speakers to Channel 2. Speaker wire should be connected to Pin1+ and Pin1- within the mating connector.
- 4 Channel 2 Multi-way Binding post speaker connectors. Red is positive and Black is negative. Take care to assure no frayed strands of wire are bridging between the connectors. This can be simplified by not stripping an excessive amount of insulation from the speaker wire.
- 5 Channel 1 Multi-way Binding post speaker connectors. Red is positive and Black is negative. Take care to assure no frayed strands of wire are bridging between the connectors. This can be simplified by not stripping an excessive amount of insulation from the speaker wire.
- 6 Channel 1 Speakon<sup>®</sup> connector. Used to connect speakers to Channel 1. Speaker wire should be connected to Pin1+ and Pin1- within the mating connector. Channel 1's Speakon<sup>®</sup> connector can be used to deliver the speaker level audio to a single speaker when the amplifier is set to the MONO configuration. See page 8 for more information.

- 7 Serial Number Label should not be removed. This label contains the serial number and manufacturing information, and removal will void the product's warranty.
- 8 Cooling Fans. Care should be taken to insure that the fans are always in proper working order and that they are clean and free from any build up of dust or debris. Never place the amplifier in a position that would block the free flow of fresh air from the fans. The direction of airflow is from the rear to the front of the amplifier.
- 9 Input connectors. An XLR connector and a 1/4" TRS connector are provided for each channel. Within a channel the XLR and TRS connectors are wired in parallel.
- 10 Threshold adjustment for the "Signal Smart" feature of the amplifier.
- 11 DIP Switches for selecting various features of the amplifier.

# Installation

## Location and General Precautions

Observe the following precautions when choosing a location for your amplifier.

A. Do not expose the unit to rain or moisture. If a fluid or foreign object should enter the unit, disconnect the power plug and contact an authorized dealer or service center. Do not pull out the plug by pulling on the cord; grasp the plug firmly and pull from socket.

B. Protect from heat and allow adequate ventilation. Place away from direct sources of heat, such as heating vents and radiators. All components produce some heat during operation, so make sure that the ventilation holes are not covered and that air is allowed to circulate freely behind, beside and above the amplifier. Excessive heat is the single greatest cause of component failure.

## Mechanical Considerations

The Xi1850 and Xi2600 require three rack space units (5.25") and a depth of 16" inside the rack, including the rear supports. Secure the unit mechanically using four screws with washers to prevent marring the front panel.

## Rear Support for Road Applications

If the Xi amplifier is rack mounted and the rack is transported, mechanical support for the rear of the amplifier is required. This could take the form of a shelf across the rear of the amplifier or brackets that engage the rear of the amplifier. Rear support is recommended in all Xi amplifier installations.

## Thermal Considerations

When the Xi amplifiers are used free-standing, no thermal considerations are necessary other than keeping the ventilation holes open. If the amplifiers are rack mounted, ensure that adequate ventilation exists if front of and behind the amplifier. When several amplifiers are mounted together in a rack, you may need to provide air inlets from the outside of the rack. The Xi amplifiers are fan cooled. The fan is internally mounted so that it draws air from the rear of the chassis and exhausts it out the front. The Xi amplifiers may be stacked directly on top of each other without spacer panels. If the amplifiers are used with other amplifiers, ensure that the heat output from the other amplifiers does not interfere with the ventilation of the Xi amplifiers (or vice versa).

## AC Power Considerations

Ensure that the Xi amplifier is plugged into an outlet capable of supplying the correct voltage specified for your model and enough current to allow full-power operation of all amplifiers plugged into the outlet. The current demand of a power amplifier varies depending on several factors, including the impedance of the load, the output level of the amplifier, and the crest factor and duty cycle of the program material. Under typical conditions reproducing rock music, with both channels driven into a 4 ohm load to the point where musical peaks are just at the clipping point, the amplifiers require the following current:

**Xi1850:** 525W (7.2A) for 117V versions, 525W (3.5A) for 234V versions

**Xi2600:** 700W (10A) for 117V versions, 600W (4.0A) for 234V versions

## Magnetic Leakage Considerations

The Xi amplifiers may be mounted without concern for magnetic flux leakage, within the confines of common sense. For example, it is not a good idea to mount a power amplifier near a microphone input transformer or magnetic storage media.

The input signal can be used with either unbalanced shielded single conductor or balanced shielded two conductor cables. Use shielded cable to conduct the signal from the source (i.e. mixer, equalizer, CD player, etc.) to the amplifier.

## For Balanced Operation:

**1/4" Phone Jack:** Use a 3-conductor TRS (tip-ring-sleeve) 1/4" Phone Plug. The tip carries the "+" (high, non-inverted) side of the signal, the ring carries the "-" (low, inverted) side of the signal and the sleeve is signal ground (see Figure A).

**XLR:** Use a male XLR connector. Pin 2 carries the "+" (high, non-inverted) side of the signal, Pin 3 carries the "-" (low, inverted) side of the signal and Pin 1 is signal ground. (See Figure B).

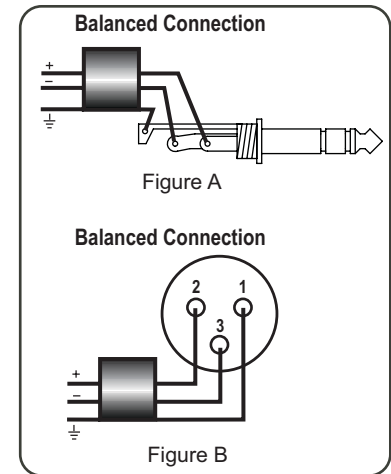

## For Unbalanced Operation:

**1/4" Phone Jack:** Use a 3-conductor TRS (tip-ring-sleeve) 1/4" Phone Plug. The tip carries the "+" (high, non-inverted) side of the signal, the sleeve is signal ground connect the sleeve to the ring. (see Figure C).

**XLR:** Use a male XLR connector. Pin 2 carries the "+" (high, non-inverted) side of the signal, Pin 1 is signal ground, Pin 3 is jumpered to Pin 1. (See Figure d).

## Input Sensitivity

The input sensitivity of the Xi amplifiers is set at the factory to 1.55VRMS for rated output. The input sensitivity can be changed to 0.775VRMS by using the appropriate DIP switch on the rear panel. The input sensitivity can be set independently for each channel.

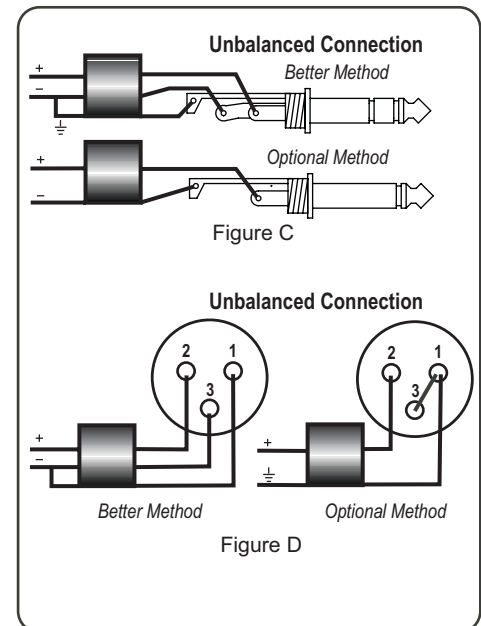

## Output Wiring

Use heavy gauge cable for speaker connections. The greater the distance between the amplifier and the speakers, the larger the diameter the cable should be to minimize power losses across the cable and improve the damping of the speaker. Cable thickness specifications (or gauges) get larger as the cable gets thinner; thus 14-gauge cable is thicker than 16-gauge cable. Use the following as a guide: Up to 25 feet use 16-gauge, up to 40 feet use 14-gauge, up to 60 feet use 12-gauge, up to 100 feet use 10-gauge, up to 150 feet use 8-gauge and up to 250 feet use 6-gauge speaker cable. This will ensure that the resistance of the speaker cable is less than 5% of 4-ohms, resulting in a transmission loss of less than 0.5 dB. With Xi amplifiers Class 2 (NEC) cable may be used. In Bridged Mono operation Class 1 (NEC) cable must be used.

## Multi-Way Binding Posts:

Xi amplifiers can accept spade connectors, bare wire, or banana connections (except CE approved versions). Be sure that all the fine strands of the cable are twisted together and contained within the connector. If even one strand is loose and can touch the adjacent terminal, a short circuit may result.

## Speakon:

Must use Neutrik® Speakon® 4 position female connector (NL4FC) or equivalent. Use speaker cable gauges as specified above for optimum performance. Stereo or paralleled configuration for both channels: Pin 1+ is positive, and Pin1- is negative. Using the Mono Bridged connector, (CH1) Pin 2+ is positive and Pin1+ is negative. (see Figure E)

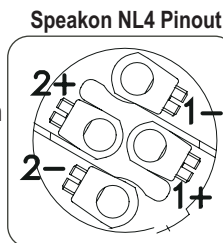

Figure E

## Polarity:

Loudspeakers must be connected with consistent polarity for correct phasing between them. Incorrect phasing will do no physical harm, but frequency response will be affected. The key is to make sure that both speakers connected to the speaker terminals are hooked up the same way. Connect (-) at the speaker outputs to (-) on the back of the speaker, and (+) at the speaker outputs to (+) on the back of the speaker.

## Bridged Mono Operation

When in Bridged Mono mode, connect the input signal to CH2 input (CH1 input becomes disabled). Connect the speaker(s) to the two red (+) binding posts. The CH2 (+) terminal is the hot (+) (non-inverting) side, and the CH1 (+) terminal is the low (-) (inverting) side. When connected in this way, each channel “sees” one-half the impedance of the speaker(s) connected between them. If an 8-ohm speaker is used, each channel will see a 4-ohm load. Therefore, it is not recommended that any load lower than a 4-ohm load be connected in this mode of operation. In Bridged Mono operation Class 1 (NEC) cable must be used. Use Dual Mono mode for lower impedances. (To use Speakon® connectors in Bridged Mono mode see the paragraph above referencing Speakon®)

**NOTE:** Be sure to set both CH1 and CH2 input level controls to the same setting for equal power distribution to the inverted and non-inverted signals.

**WARNING:** In bridged mono operation, the output connections are actually a balanced output configuration. This means that both output terminals have potentially high voltages present (neither one may be grounded).

## Dual Mono:

To configure the amplifier for Dual-mono operation, change the output configuration switches located on the rear panel of the amplifier. Connect the input source to CH2 (CH1 input is now disabled). Connect speaker(s) to either CH1, or CH2, or both.

## DIP Switches:

The Xi Amplifiers have an eight position DIP switch located at the input of each channel on the rear of the amplifier. (see Figure F)

### CH1 DIP Switch (top to bottom)

- Clip Limiter
- Low Pass (select 120Hz or 80Hz)
- Low Pass Filter (select On / Off)
- High Pass (select 80Hz or 40Hz)
- High Pass Filter (select On / Off)
- Sensitivity (select 0.775V or 1.55V)
- CH1 Level Control Bypass
- Mono Operation (select Dual or Bridged)

### CH2 DIP Switch (top to bottom)

- Clip Limiter
- Low Pass (select 120Hz or 80Hz)
- Low Pass Filter (select On / Off)
- High Pass (select 80Hz or 40Hz)
- High Pass Filter (select On / Off)
- Sensitivity (select 0.775V or 1.55V)
- CH1 Level Control Bypass
- Operation (select 2 Channel or Mono)

## Signal Smart:

Signal Smart is an energy saving circuit in the Xi amplifiers. When the amplifier is idle for more than three minutes “Signal Smart” will cause the amplifier to go into a “standby mode” that significantly reduces current draw in the amplifier.

Find the “Signal Smart Threshold” adjustment on the rear of the amplifier (see figure F). A range from -40dB to -20dB is available. At -40dB very little signal is required to keep the amplifier turned “ON” and is considered to be a “Bypass” setting for the “Signal Smart” feature. At a setting of -20dB a much larger amount of signal is required to overcome the standby function of the “signal smart” circuit. A setting of about -30db will be virtually transparent to the user. Once the threshold has been passed an amplifier that is in standby will return to its full potential in approximately 40 milliseconds, or about the time it takes to blink your eyelid. Sonically, this is transparent and causes little or no abbreviation of the sound if the threshold is not set to high (-20db).

Turning the threshold control fully counter-clockwise will bypass the “Signal Smart” feature on the amplifier.

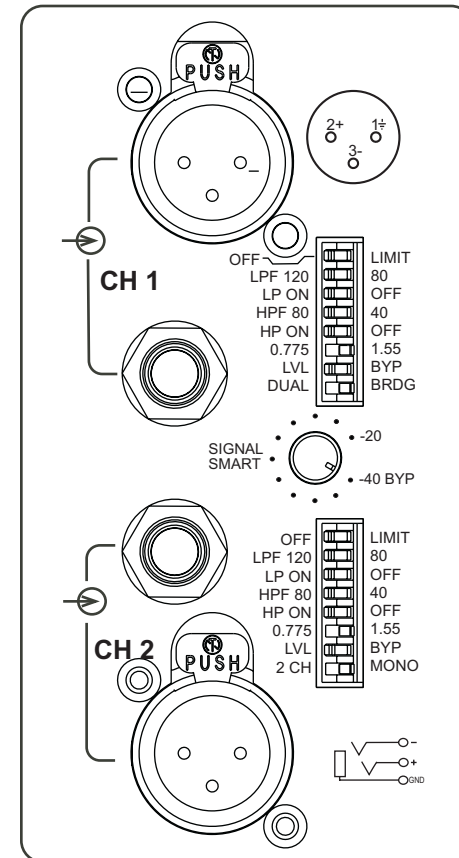

Figure F



### 70V Direct-Drive Operation:

The Xi1850 and the Xi2600 have sufficient output voltage capability in stereo mode to direct-drive 70-volt distribution systems without using a step-up transformer at the amplifier. In this configuration, the Xi1850 delivers up to 370 watts per channel and the Xi 2600 500 watts per channel to the 70V system, depending on the impedance of the total system. As with all 70V systems, step-down transformers are still required at each loudspeaker. The Xi1850 can deliver 370 watts per channel into an 8 ohm impedance (54.41V line voltage). The Xi2600 can deliver 500 watts per channel into an 8 ohm impedance (63.25V line voltage).

The price for going direct is having to calculate the new transformer tap values at the new line voltage. Since watts are proportional to the square of the voltage, compute the correction factor by taking the ratio of the square of the line voltages. then multiply each tap value by this correction factor. For example, choose a transformer that has tap values at 10W, 5W and 2.5W when used in a 70.7 volt distributions system.

Its new tap values when used with an Xi1850 are computed as follows:

- 1) Complete correction factor K:

$$K=54.41V^2/70.7V^2$$
$$K=0.59$$

- 2) Apply to tap value:

$$10W \times 0.59= 5.9W$$
$$5W \times 0.59= 2.95W$$
$$2.5W \times 0.59= 1.74W$$

Its new tap values when used with an Xi2600 are computed as follows:

- 1) Complete correction factor K:

$$K=63.25V^2/70.7V^2$$
$$K=0.80$$

- 2) Apply to tap value:

$$10W \times 0.80= 8.0W$$
$$5W \times 0.80= 4.0W$$
$$2.5W \times 0.80= 2.0W$$

When used in a 70.7 volt distribution system, this transformer's new tap values are as noted above. Note that the 3dB power relationship between each tap still holds true. Similarly, maximum amplifier loading occurs when the sum of the "New" tap values equals the amplifier's output power per channel into the 8-ohm load.

# Performance Specifications

## Xi1850 / Xi2600

<b>THD+N:</b>	<0.5% @ rated power (8 ohm), 20-20kHz <0.5% @ rated power (4 ohm), 20-20kHz 1% @ rated power (2 ohm), 1kHz 1% @ rated power (8 ohm), bridged 1% @ rated power (4 ohm), bridged <0.2%, 60Hz/7kHz, 4:1, 35Vpeak @ 4 ohms
<b>IMD (SMPTE):</b>	1.5dB
<b>Dynamic Headroom:</b>	20-20 kHz @ 4 and 8 ohm loads
<b>Power Bandwidth:</b>	20-20kHz, +0dB/-1dB
<b>Frequency Response:</b>	>100dB, A-Weighted, referenced to 4 ohm rated power
<b>Signal-to-Noise:</b>	> -70dB @1kHz referenced to rated power (4 ohm)
<b>Crosstalk:</b>	70dB at 1kHz
<b>CMRR:</b>	20V/uSec
<b>Slew Rate:</b>	0.775Vrms or 1.55Vrms (Selectable)
<b>Sensitivity for rated power:</b>	50k balanced
<b>Input Impedance:</b>	20dBu
<b>Input Overload:</b>	Thermal, Short Circuit, Over-Current & Over Voltage
<b>Protection:</b>	Unconditionally stable into reactive loads at 1/3 rated output power
<b>Stability:</b>	Continuous operation at 1/3rd power
<b>Duty Cycle:</b>	

### POWER REQUIREMENTS:

#### Mains Voltage (output power rated at nominal voltage):

100VAC (50-60Hz) ±10%
117VAC (60Hz) ±10%
234VAC (50Hz) ±10%

#### Current consumption @ 1/8 rated power, pink noise:

##### Xi2600

8-ohm x 2	500W (7.0A) 117V/60Hz	400W (2.8A) 234V/50Hz
4-ohm, x 2	700W (10A) 117V/60Hz	600W (4.0A) 234V/50Hz
2-ohm x 2	1250W (15A) 117V/60Hz	1100W (7.5A) 234V/50Hz

##### Xi1850

8-ohm x 2	340W (4.9A) 117V/60Hz	340W (2.3A) 234V/50Hz
4-ohm x 2	525W (7.2A) 117V/60Hz	525W (3.5A) 234V/50Hz
2-ohm x 2	850W (10.8A) 117V/60Hz	825W (5.3A) 234V/50Hz

# Limited Warranty Information

## Xi Series Power Amplifiers: 5 Years\*

\* The following limited five year warranty is exclusive to the United States and its possessions and territories. In all other countries the warranty is limited to two years. Please see your Carver Professional dealer or distributor for the correct limited warranty information in your area or locale.

### WHAT IS COVERED:

THIS LIMITED WARRANTY COVERS DEFECTS IN MATERIAL AND WORKMANSHIP ONLY. This limited Warranty DOES NOT extend to: 1) damage caused by shipment, 2) damage caused by accident, misuse, abuse, failure to perform owner maintenance, or operation contrary to the instructions in the Carver Professional owner's manual, 3) units on which the serial number has been defaced, modified or removed and 4) damage resulting from modification or attempted repair by any other person than authorized by Carver Professional.

### WHAT WE WILL PAY FOR:

Carver Professional will pay all labor and material expenses for items covered under this Limited Warranty. See the next section concerning shipping charges.

### WHAT YOU MUST DO TO OBTAIN WARRANTY SERVICE:

In the event your Carver Professional product requires service, contact your Carver Professional Authorized Dealer / Contractor or contact Carver Professional (ATTN: Customer Service Dept.) 9300 North Decatur, Portland, OR 97203, or call Customer Service Department directly at (503) 978-3317. You will be directed to an Authorized Carver Professional Service Station or receive instructions to ship the unit to the factory. Please save the original carton and packing materials in case shipping is required. **Please do not ship parcel post.** Include a complete description of the problem, the associated components and connections, and a copy of the purchase receipt. Carver Professional does not pay initial shipping costs. Return shipping costs will be pre-paid if repairs were covered by the scope of this warranty.

### YOU MUST RETAIN AND PROVIDE YOUR SALES RECEIPT TO OBTAIN COVERAGE UNDER THIS LIMITED WARRANTY.

The warranty period begins from the date of the first consumer purchase from an Authorized Carver Professional Dealer. Any implied warranties for merchantability and fitness for a particular purpose required by any state law are limited in duration to the warranty period of your product. The warranty set forth above is exclusive and no other, written or oral is expressed or implied. Carver Professional specifically disclaims the implied warranties and merchantability and fitness for a particular purpose.

### EXCLUSION OF CERTAIN DAMAGES:

In no event shall Carver Professional be liable for property damage, or any other incidental or consequential damages, which may result from failure of this product. If your Carver Professional product proves defective in material or workmanship, the liability of Carver Professional shall be limited to the repair or replacement, at the option of Carver Professional, of any defective part.

### STATE LAWS MAY DIFFER:

Some states do not allow limitations on how long an implied warranty lasts and/or do not allow the exclusion or limitation of incidental or consequential damages, so the above limitations may not apply to you. This warranty gives you specific legal rights, and you may have other rights, which vary, from state to state.

### OTHER IMPORTANT PROVISIONS:

Carver Professional reserves the right to make changes in design and improvements to its products without the responsibility of installing such changes or improvements on products previously sold by Carver Professional. We suggest that you attach your purchase receipt to this Warranty and keep both documents in a safe place. Thank you for your choice of a Carver Professional Amplifier.

## CARE AND SERVICE ASSISTANCE

**Care:** Wipe off the Xi Series Amplifier's front panel and chassis from time to time, with a soft, dry cloth. If you have something stubborn to remove, use a mild dish soap or detergent sparingly applied to a soft cloth. Don't use alcohol, ammonia or other strong solvents.

**Service Assistance:** We suggest that you read the Limited Warranty completely to fully understand your warranty/service coverage. Please promptly complete and return the Warranty registration card. Also, be sure to save the sales receipt in a safe place. It will be necessary for warranty service. If your Carver Professional product should require service, you may contact the Carver Professional Technical Service Department by calling (503) 978-3399 or by writing to us at the Factory address below. We will then direct you to the nearest in our national network of Authorized Warranty Service Centers, or give you detailed instructions on how to return the product to us for prompt action. If you should have questions or comments, please write to the Factory address below, or contact us via email at [support@carverpro.com](mailto:support@carverpro.com) or at our web site: [www.carverpro.com](http://www.carverpro.com). Please include the model and serial number of your Carver Professional product, your complete address and daytime phone number.

### Carver Professional

Service Department  
9300 North Decatur Street  
Portland, Oregon 97203  
Phone 503.978.3334 Fax 503.978.3302  
Email: [support@carverpro.com](mailto:support@carverpro.com) Web: [www.carverpro.com](http://www.carverpro.com)

### Carver Professional

Customer Support  
9300 North Decatur Street  
Portland, Oregon 97203  
Phone 503.286.9300 Fax 503.978.3302  
Email: [support@carverpro.com](mailto:support@carverpro.com) Web: [www.carverpro.com](http://www.carverpro.com)

Carver Professional reserves the right to improve its products at any time. Therefore, specifications are subject to change without notice.



**Carver Professional**

9300 North Decatur Street

Portland, Oregon 97203

Phone 503.286.9300 Fax 503.978.3302

Email: [support@carverpro.com](mailto:support@carverpro.com) Web: [www.carverpro.com](http://www.carverpro.com)